

# 5. РАЗРЕД

## Графичко обликовање

### "конструкција"

## Изометријски приказ

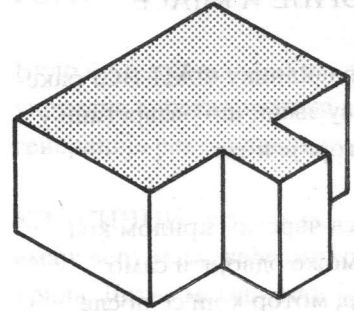

фазе обликовања - алгоритам

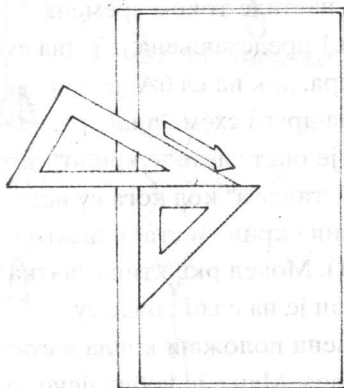

**а**

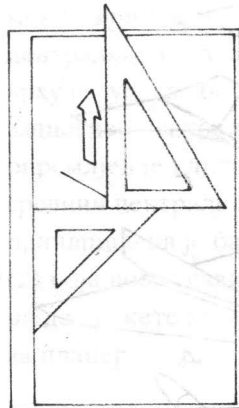

**б**

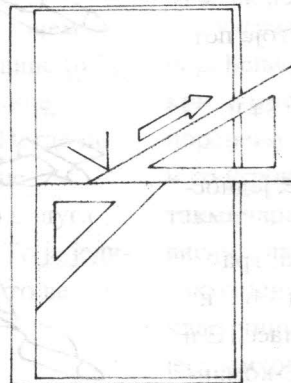

**в**

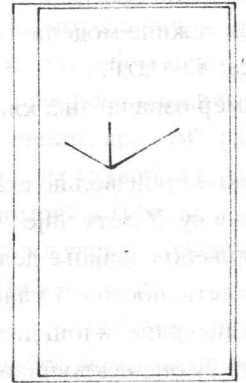

**г**

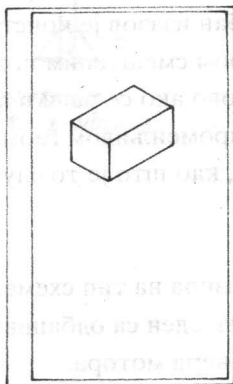

**д**

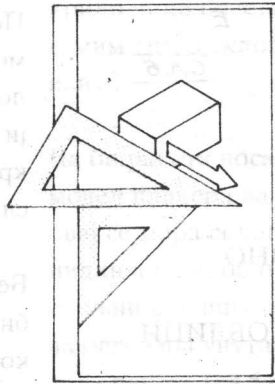

**е**

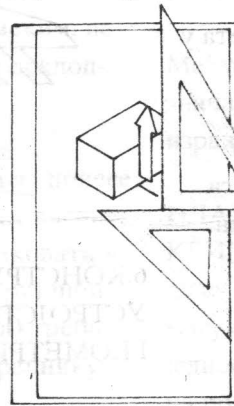

**ж**

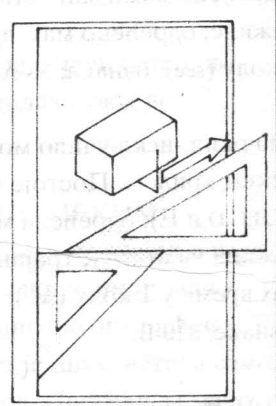

**з**

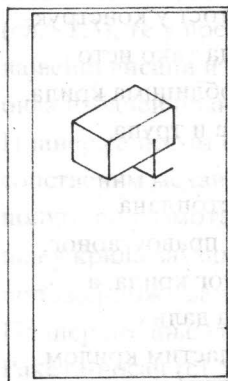

**и**

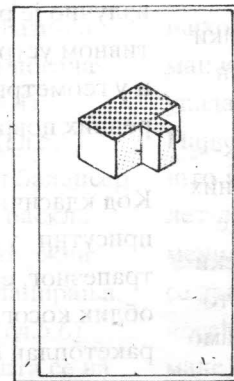

**м и г.**

Графичко обликовање "конструкција"

**Ортогонални приказ**

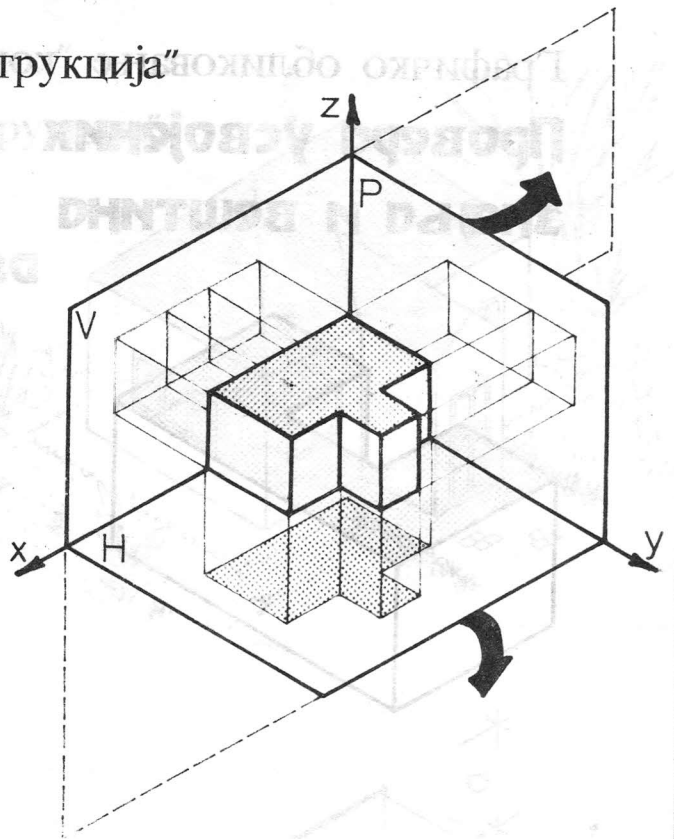

фазе обликовања - алгоритам

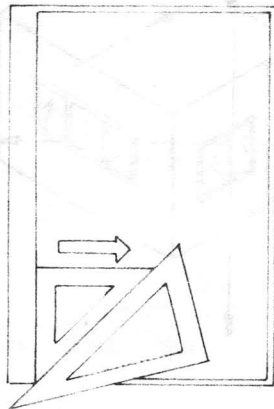

**а**

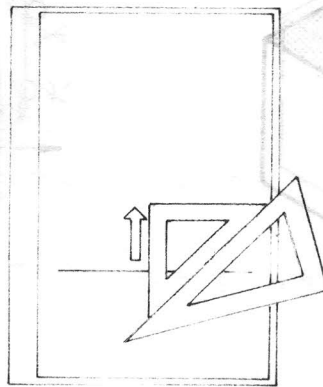

**б**

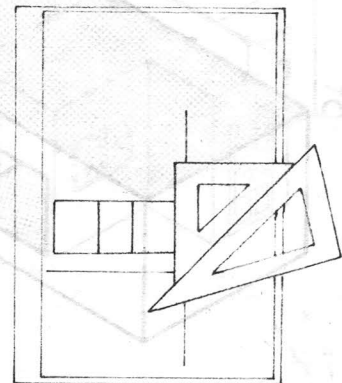

**в**

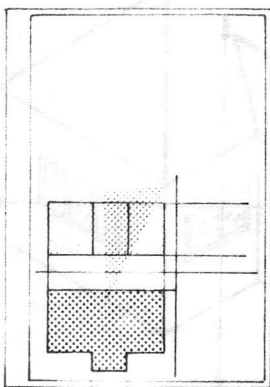

**г**

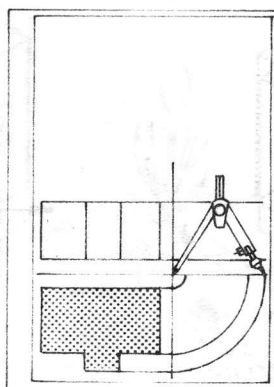

**д**

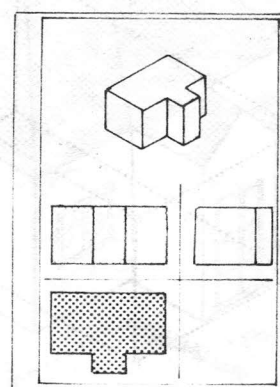

**е**

